



www.americanringmfg.com

## 5144-056 Retaining Ring Spec Sheet



**Part Number: 5144-056**  
5144 - Reinforced E Ring

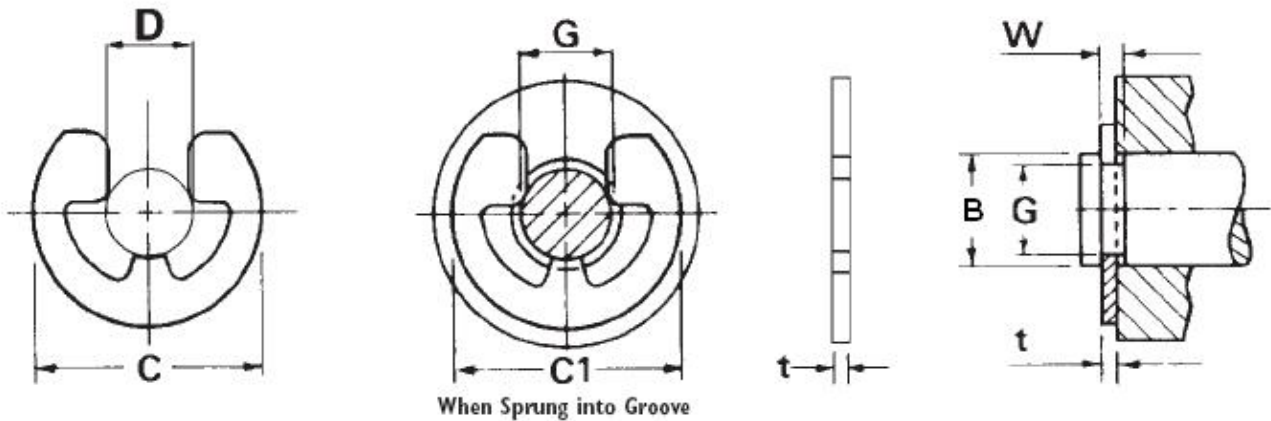

### Ring Specs

<b>(D) Free Diameter:</b>	0.430	+0.004 / -0.004	in.
<b>(t) Thickness:</b>	0.042	+0.002 / -0.002	in.
<b>(b) Radial Wall:</b>			

### Groove Specs:

<b>(B) Application Diameter:</b>	0.562		in.
<b>(G) Groove Diameter:</b>	0.437	+0.003 / -0.003	in.
<b>(W) Groove Width:</b>	0.046	+0.003 / -0.000	in.
<b>Groove Depth:</b>	0.063		in.

### Other Specs

<b>Approximate Weight per 1000:</b>	3.500		lbs.
<b>(C) Free Outside Diameter</b>	0.870		in.
<b>(C1) Clearance Diameter when Sprung into Groove</b>	0.890		in.

